

BBF RFC 101: Logic Gene Module Standard

Lingjue Wang, Yin Tong, Liquan Zhou, Zhuangdian Ni, Xiaodan Zhu, Hanrun Li

2013.10.16

1. Purpose

This Request for Comments (RFC) describes a new framework for standardize logic gene relations among gene circuits. Each type of logic module in gene circuit can be summarized in a standard device in electronics. In this paper, we collect several frequently-used logic modules and the corresponding classic gene structure.

2. Relation to other BBF RFCs

This Request for comments doesn't reference other RFCs.
This Request for comments is a support for RFC 102: Genetic Standard (version 2.0).

3. Copyright Notice

Copyright (C) The BioBricks Foundation (2013). All Rights Reserved.

4. Content

- 4.1 Introduction
- 4.2 Definition of Logic Gene Module
- 4.3 Functions of Logic Gene Module (with samples)
 - 4.3.1 AND & NOT & NAND gate
 - 4.3.2 Toggle Switch
 - 4.3.3 Oscillator
 - 4.3.4 Counter
 - 4.3.5 Combinatorial Gate
- 4.4 For Developers

➤ 4.1 Introduction

So far, there are plenty of genetic circuits executing various functions. Among them, different types of logic modules are used to regulate the genetic network. In order to construct a genetic circuit more conveniently and regularly, we establish this standard to sort out several classic frameworks for the logic gene modules of gene circuits. Additionally, this standard will be continuously updated since the regulatory modules can be assembled into more complicated modules.

➤ 4.2 Definition of Logic Gene Module

To meet the need of a logic gene circuit, a logic gene module **SHOULD** be a specific gene device which **SHOULD** function like an electron component which can accept some certain stimulation and emit some other signals. A logic gene module **SHOULD** be designed based on a specific and functional logic component in electronics such as the AND gate. Furthermore, it **MUST** be constructed of the standardized biobricks so that it **WILL** fully compatible with other parts of the gene circuit.

➤ 4.3 Functions of Logic Gene Module (with samples)

Logic gene module has various functions. It can judge the input conditions and give a disparate output result. It can either amplify or diminish the input signals. Anyways, a logic gene module **MUST** execute a certain function. Here are some classic samples of logic gene modules:

- AND & NOT & NAND gate

AND gate is a basic logic gate that implements logical conjunction. A HIGH output results only if both the inputs to the AND gate are HIGH. If neither or only one input to the AND gate is HIGH, a LOW output results. $C = A \cdot B$.

Standard input and output of Logic AND gate

Input A	1	1	0	0
Input B	1	0	1	0
Output C	1	0	0	0



In the sample, the σ^{54} hrpL promoter is activated only when both input genes are expressed under the environment-responsive promoters P_{lac} & P_{BAD} (Figure 1.a). And the result is shown in Figure 1.b.

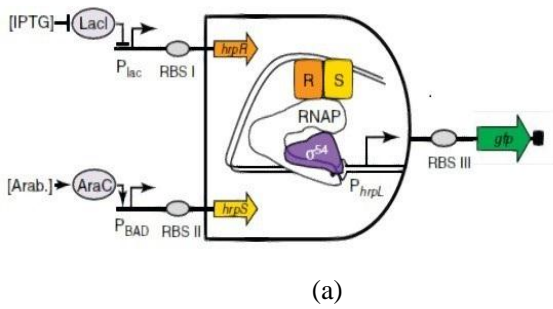
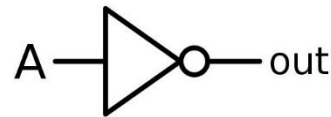

Figure1 (a) A classic sample diagram of AND gate. (b) The result of the sample. Only the Arabinose and IPTG are both existing in a certain concentration can the P_{hrpL} gene be activated and as a result producing the green fluorescent protein.

The NOT gate (inverter) is a basic logic gate that implements logical negation. A HIGH output results only if the input to the NOT gate is LOW. If input to the NOT gate is HIGH, a LOW output results. $C = \text{NOT } A$.

Standard input and output of Logic AND gate:

Input	Output
1	0
0	1
A	Not A



In the sample, under the presence of red light, the kinase activity of Cph8 is inhibited, precluding the transfer of a phosphoryl group (light green circle) to the response regulator OmpR (orange dumbbell) and subsequent transcription from the ompC promoter (P_{ompC}). The dark sensor therefore functions as a NOT light transcriptional logic gate (Figure2.a).

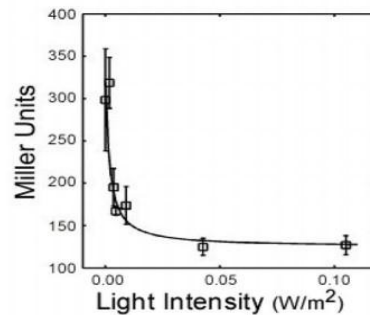
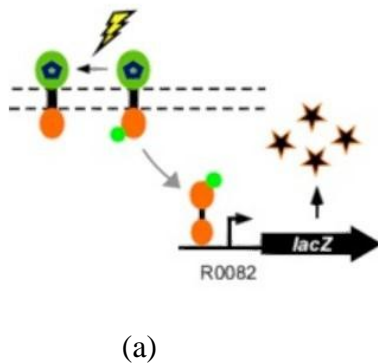

Figure2 (a) A classic sample diagram of NOT gate. (b) The result of the sample. When the red light appears, there is a big change of the phosphoryl group concentration.

The NAND gate is a basic logic gate that implements logical conjunction. A HIGH output results only if both the inputs to the NAND gate are LOW. If neither or only one input to the NAND gate is LOW, a HIGH output results. $C = \text{NOT } (A \cdot B)$.

Standard input and output of Logic NAND gate:

Input A	1	1	0	0
Input B	1	0	1	0
Output C	0	0	0	1



In the sample, the GFP protein is not expressed only when both input genes are expressed under the environment-responsive promoters (P_{lac} and P_{BAD}), and in other cases the GFP protein is expressed.

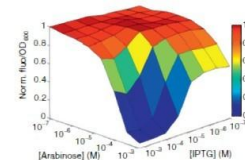
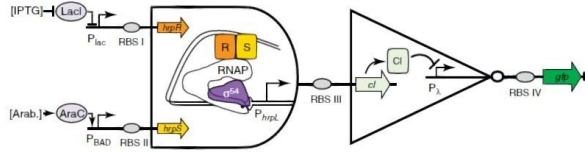

(a)

(b)

Figure3 (a) A classic sample diagram of AND gate. (b) The result of the sample. The GFP expressed much more when the Arabinose and IPTG decrease in a small concentration.

● Toggle Switch

A toggle switch is a class of electrical switches that are manually actuated by a mechanical lever, handle, or rocking mechanism. The word "toggle" is a reference to a kind of mechanism or joint consisting of two arms, which are almost in line with each other, connected with an elbow-like pivot. However, the phrase "toggle switch" is applied to a switch with a short handle and a positive snap-action, whether it actually contains a toggle mechanism or not. Similarly, a switch where a definitive click is heard, is called a "positive on-off switch".

Input A	on 'A' off 'B'
Input B	on 'B' off 'A'

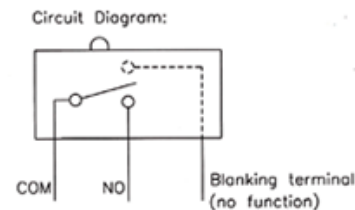

In the classic sample, repressor 1 inhibits transcription from Promoter 1 and is induced by Inducer 1. Repressor 2 inhibits transcription from Promoter 2 and is induced by Inducer 2.

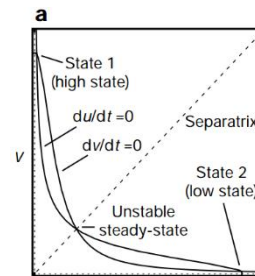
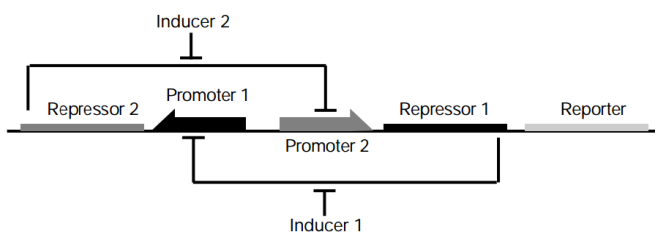

(a)

(b)

Figure4 (a) A standard framework of genetic toggle switch. (b) The mathematical model of the genetic toggle switch.

● Oscillator

An oscillator is a semiconductor device, consisting of a semiconductor specimen placed in magnetic field, and a resistor after a power supply. The device produces high-frequency oscillations, which are very close to sinusoidal.

	Electronic	Biology
Input	DC (Direct Current) (start)	Positive start
Output	AC (Alternating Current)	Oscillating feedback

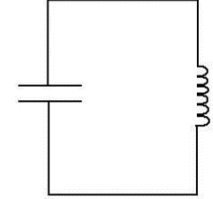

In the sample, external stimulus or the circuit itself will firstly start with expressing the positive feedback protein and enhancing promoter. In the first cycle, two kinds of proteins increase. When the repressed protein increases to a certain degree, the promoter will be repressed and as a result, causing a negative feedback. Two proteins decrease until the negative impact eliminate and the promoter will start to work again. And the state of the circuit come back to the original state. Following that the oscillator circuit will enter another cycle.

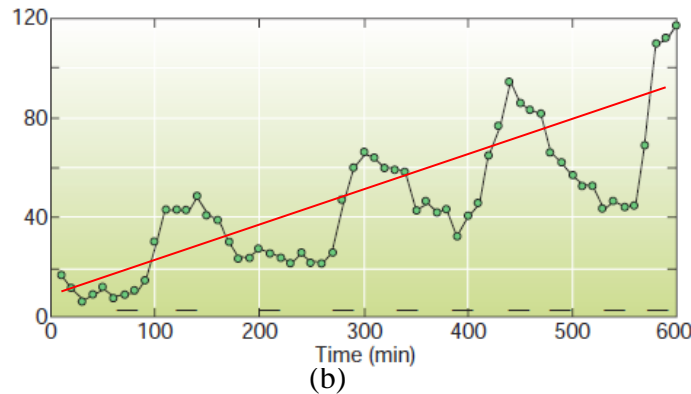
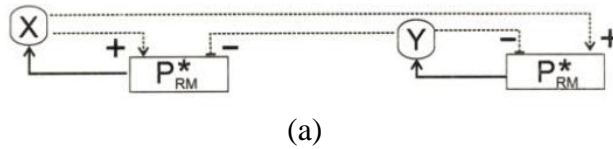
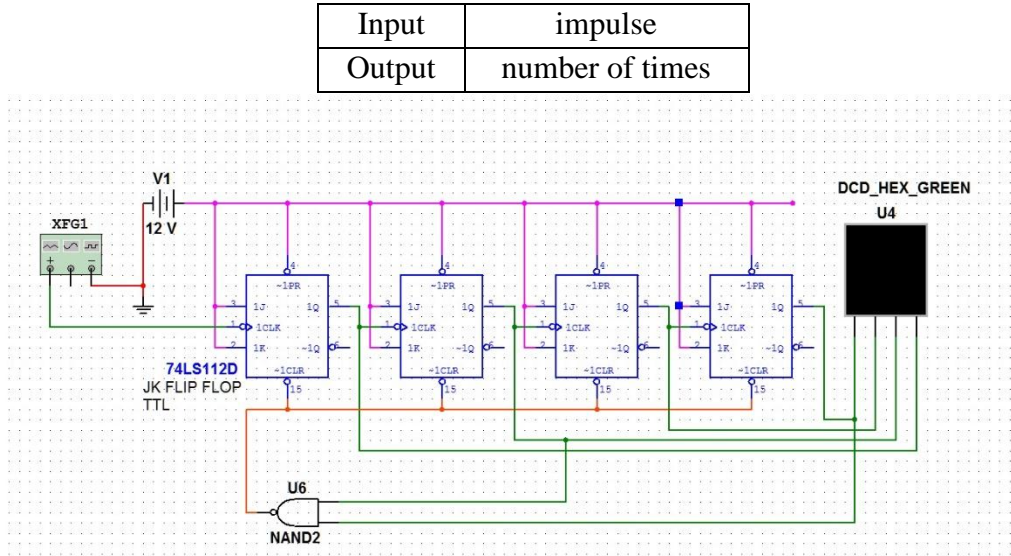

Figure5 (a) A standard framework of genetic oscillator. One promoter with two regulatory proteins (a repressed one and a enhanced one) (b) the result of a genetic oscillator. The overall concentration of the product is increasing.

- Counter

In digital logic and computing, a counter is a device which stores (and sometimes displays) the number of times a particular event or process has occurred, often in relationship to a clock signal.



T7 RNAP is the gene at the first node driving transcription of T3 RNAP, which ultimately drives transcription of GFP. All transcripts are likewise cis-repressed with the same ribo-regulator sequence. When pulsed with arabinose, this counter should primarily produce T7 RNAP proteins during the first pulse, T3 RNAP proteins during the second pulse, and GFP proteins during the third pulse.

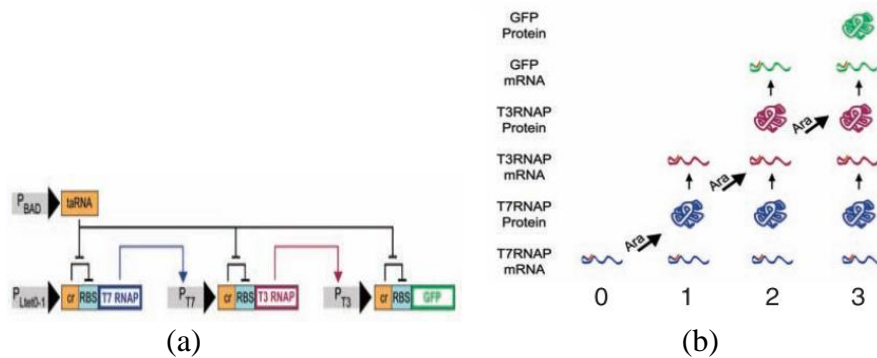

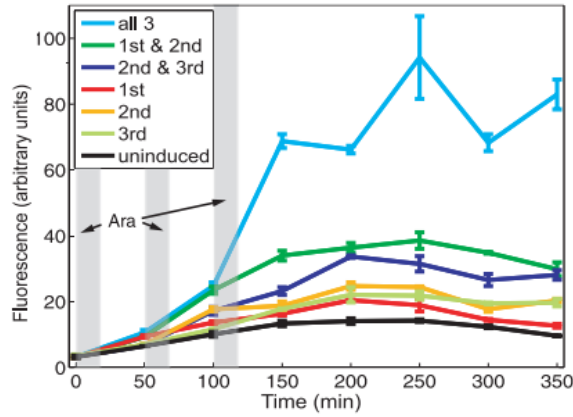

(c)

Figure6 (a) A sample of genetic counter (the genetic module). (b) The diagram of the mechanism. (c) The result of the sample.

- Combinatorial gate

A combinatorial gate is composed of some logic gates such as the AND, NOT, NOR, NAND gates, etc. As you design the electric circuits, these logical gene gates can be connected in parallel or in series or even both. This combination can bring more complicated and stratified regulatory network.

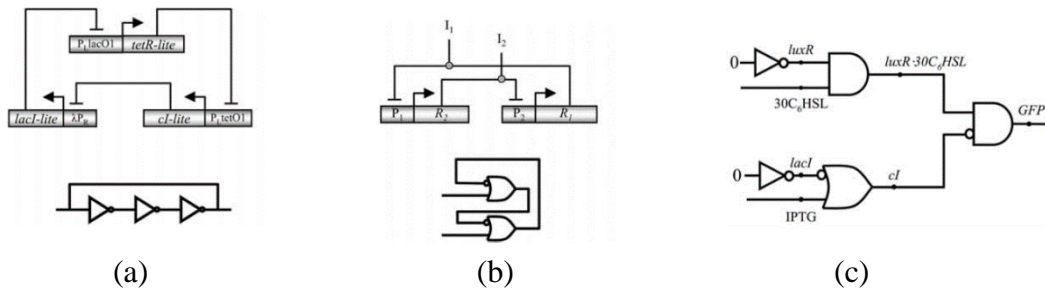

(a)

(b)

(c)

Figure7 these figures are some kinds of combinatorial gates. (a) The repressilator circuit. (b) Toggle switch. (c) Circuit to decode two incoming signals.

A sample of combinatorial gate:

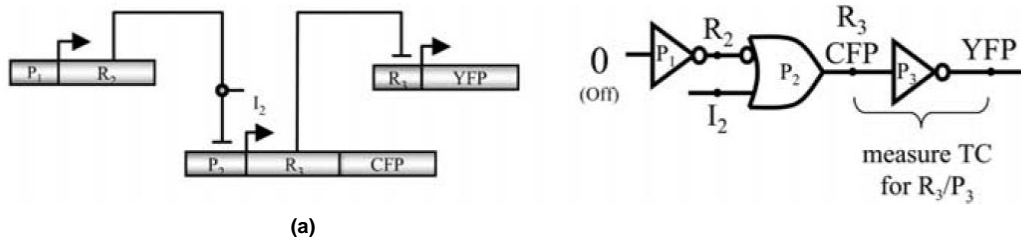

(a)

(b)

Figure8 Genetic circuit to measure the device physics of an R3/P3 inverter: digital logic circuit and the genetic regulatory network implementation (Px: promoters, Rx: repressors, CFP/YFP: reporters).

In the sample, P_1 promoter regulates the expression of R_2 . R_2 is expressed constitutively and the gate's output is high. R_2 is the repressor for promoter P_2 . P_2

regulates R_3 . If we add an external inducer I_2 which can bind R_2 and as a result R_2 cannot bind to the operator site of P_2 . A reporter CFP is placed downstream of R_3 to give a signal. What's more, R_3 is a repressor of promoter P_3 . There is another reporter YFP located in downstream of P_3 . This circuit can be applied with different repressor/promoter pairs. (E.g: $P_1 = \lambda_{P(R-O12)}$, $P_2 = P_{LtetO-1}$, $P_3 = p(lac)$. Inducer $I_2 =$ anhydrotetracycline(aTc). $R_2 =$ TetR protein and $R_3 =$ LacI protein).

➤ 4.4 For Developers

Based on this standard, we always welcome everyone to add new logic gene modules like we've introduced above. If you have some new ideas about the logic gene modules you can email any of us (Our email addresses will be listed below). This standard is established for supporting the genetic circuit standard.

5. Author's Contact Information

Lingjue Wang: sustc.mikewong@gmail.com

Yin Tong: ty25177@yahoo.com.cn

Liqun Zhou: jimzhou225@gmail.com

Hanrun Li: lizhongminde@126.com

Zhuandian Ni: nileenstropy@gmail.com

Xiaodan Zhu: zxdedgar@gmail.com

6. References

Ari E. Friedland, et al (2009) Synthetic Gene Networks That Count. *Science* 324:1199.
J Hasty, D McMillen, JJ Collins (2002) Engineered gene circuits. *Nature* 420:224-230.
J Hasty, M Dolnik, V Rottschäfer, JJ Collins. (2002) Synthetic Gene Network for Entraining and Amplifying Cellular Oscillations. *Phys. Rev. Lett.* 88, 148101.
RON WEISS*, SUBHAYU BASU, SARA HOOSHANGI. (2003) Genetic circuit building blocks for cellular computation, communications, and signal processing. *Natural Computing* 2: 47-84